

All-in-One Health Monitor

User Instruction Manual

This manual is written for the PC-303 All-in-One Health Monitor.

The manual describes, in accordance with the All-in-One Health Monitor's features and requirements, the main structure, functions, specifications, correct methods for transportation, installation, usage, operation, repair, maintenance and storage, etc. as well as the safety procedures to protect both the user and equipment. Refer to the respective chapters for further details.

The manual is published in English and Creative has the ultimate right to explain the Manual.

For the user's convenience, we share the latest version analysis software of the All-in-One Monitor on our website, go to www.creative-sz.com to download the latest version of the data management software. Please contact the manufacturer or your local distributor if there are any issues downloading the software.

Version of This User Manual: Ver1.8

Product service life: 5 years (no warranty)

Issue Date: 3rd March 2016

Manufacturing date: See Label

All rights reserved

Material Number: 3502-2600011

 **Caution:** Federal law restricts this device to sale by or on the order of a physician.

Marks in the manual:

 **Caution:** Instructions must be followed to avoid causing harm to the user or patient.

 **Attention:** Must be followed to avoid causing damage to the All-in-One Health Monitor.





Instructions for use

Dear Customers,

Thank you for purchasing the PC-303 All-in-One Health Monitor. Please read the following information before using the device.

These instructions describe the operating procedures which are to be strictly followed, read these instructions carefully before using the All-in-One Health Monitor. Failure to follow these instructions can cause monitoring abnormalities, damage to the monitor and personal injury. The manufacturer is NOT responsible for the safety, reliability and performance issues or any monitoring abnormalities, personal injury and equipment damage due to user's negligence of the operation instructions. The manufacturer's warranty service does not cover such faults

Warnings:

-  Do NOT use the device under flammable gas conditions or in any environment that may lead to explosion.
-  The device and accessories should not be serviced or maintained while the device is in use.
-  Do not modify this equipment without authorization from the manufacturer.
-  Please check the monitor before use to verify that the accessories function safely and correctly.

- If the monitor is connected with other devices, the total leakage current may exceed the limitation and as a result this can cause potential danger to the user.
- Although biocompatibility tests have been performed on all the applied parts, under exceptional circumstances, allergic patients may have anaphylaxis. Do NOT use the monitor on patients with anaphylaxis.
- All connecting cables and rubber tubes of the applied parts should be kept away from the patient's neck to prevent suffocation.
- As a standard, please only use the components provided by the manufacturer or those that are of the same model and specifications as the accessories.
- If the monitor falls off a surface accidentally, please do NOT operate it before its safety and technical performance have been tested and positive results obtained.
- Do NOT open the device cover without authorization. The cover should only be opened by a qualified service personnel.
- When disposing of the monitor and its accessories, national regulations should be followed.
- This equipment has been tested and found to comply with the limits for a Class B digital device, pursuant to part 15 of the FCC Rules. These limits are designed to provide reasonable protection against harmful interference in a residential installation. This equipment generates uses and can

radiate radio frequency energy and, if not installed and used in accordance with the instructions, may cause harmful interference to radio communications. However, there is no guarantee that interference will not occur in a particular installation. If this equipment does cause harmful interference to radio or television reception, which can be determined by turning the equipment off and on, the user is encouraged to try to correct the interference by one or more of the following measures:

-Reorient or relocate the receiving antenna.

-Increase the separation between the equipment and receiver.

-Connect the equipment into an outlet on a circuit different from that to which the receiver is connected.

-Consult the dealer or an experienced radio/TV technician for help.

- This device complies with part 15 of the FCC Rules. Operation is subject to the following two conditions: (1) This device may not cause harmful interference, and (2) this device must accept any interference received, including interference that may cause undesired operation.
- Any Changes or modifications not expressly approved by the party responsible for compliance could void the user's authority to operate the equipment.

Table of contents

CHAPTER 1 OVERVIEW	I
1.1 Features.....	I
1.2 Product Name and Model.....	II
1.3 Intended Use	II
1.4 Impact on the Environment and Resources.....	II
CHAPTER 2 OPERATION INSTRUCTIONS.....	III
2.1 Appearance	III
2.1.1 The Front Panel.....	III
2.1.2 The Right and Upper Sides of the Device.....	V
2.2 Installation	VII
2.2.1 Power Supply.....	VII

2.2.2 Starting the Monitor.....	VII
2.3 Taking Measurements.....	VIII
2.3.1 Blood Pressure Measurement.....	VIII
2.3.2 SpO ₂ Measurement.....	XII
2.3.3 Temperature Measurement.....	XV
Note:	XVI
2.3.4 Blood Glucose Measurement (Optional for the specified compatible legally marketed Blood Glucose Monitoring System only)	XVIII
2.3.5 ECG Measurement (Optional for the specified compatible legally marketed ECG Monitor only)	XXIV
2.4 Pressure Accuracy Verification.....	XXVIII
CHAPTER 3 MONITORING SCREEN DISPLAY.....	XXXIV
3.1 Measuring Screen	XXXIV
3.2 System Setting Screen.....	XXXVII
3.3 History Data Review Screen	XXXIX
3.4 Data Uploading	XL
CHAPTER 4 TECHNICAL SPECIFICATIONS.....	XLI

4.1 Blood Pressure Measurement.....	XLI
4.2 SpO ₂ Measurement	XLII
4.3 Pulse Rate Measurement.....	XLII
4.4 Temperature Measurement.....	XLIII
4.5 Blood Glucose Measurement (Optional)	XLIII
4.6 ECG Measurement (Optional).....	XLIII
4.7 Others	XLIV
4.7.1 Operating Environment.....	XLIV
4.7.2 Classification.....	XLV
CHAPTER 5 TROUBLESHOOTING	XLVI
CHAPTER 6 PACKING LIST.....	XLVII
CHAPTER 7 MAINTENANCE AND SERVICE	XLIX
7.1 Technical Maintenance.....	XLIX
7.1.1 Daily Examination	XLIX
7.1.2 Routine Maintenance	L
7.1.3 Battery Maintenance	LI
7.2 Cleaning and Disinfection of the Main Unit	LII

7.3 Cleaning and Disinfection of Accessories.....	LIV
7.4 Storage	LIV
7.5 Transportation.....	LV

CHAPTER 1 OVERVIEW

1.1 Features

- ✧ Small in size, light in weight, easy to carry and operate;
- ✧ Clear and large numeric display, segmented LCD panel, real-time clock display; Accurate blood pressure measurements can be activated or canceled by one shortcut button;
- ✧ Oximetry technique ensures quick and accurate SpO₂ & pulse rate measurements by smart sensors;
- ✧ Smart infrared temperature probe ensures quick and accurate measurements of body temperature;
- ✧ Blood pressure, oxygen saturation, pulse rate and temperature can be measured simultaneously;
- ✧ Blood Glucose Monitoring System option can be connected to the device;
- ✧ Easy ECG Monitor option can be connected to the device;
- ✧ Data storage with recall, up to 999 groups of records can be stored and recognized by patient ID.
- ✧ Power management with power saving mode, auto power off and low battery indicator;

1.2 Product Name and Model

Name: All-in-One Health Monitor

Model: PC-303

1.3 Intended Use

The All-in-One Health Monitor is a device designed for measuring the patient's physiological parameters, such as Non-Invasive Blood Pressure (NIBP), Oxygen saturation (SpO₂), Pulse Rate (PR) and Body Temperature (TEMP);

Additionally, the device is available to communicate with the compatible Blood Glucose Monitoring System and ECG monitor to make the measurement.

This device is applicable for Adult and Pediatric (age \geq 3 years old) use in clinical institutions and has no conditions or factors of contraindication.

1.4 Impact on the Environment and Resources

Low

CHAPTER 2 OPERATION INSTRUCTIONS

2.1 Appearance

2.1.1 The Front Panel

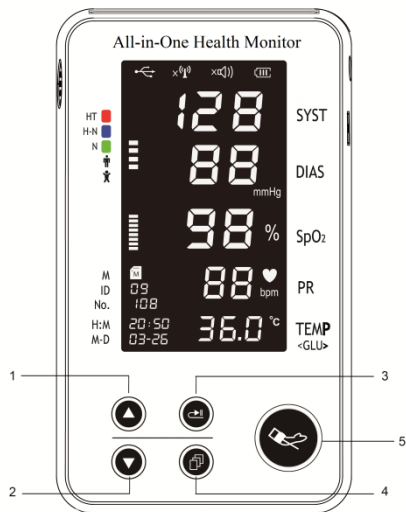









Figure 2.1 The front panel

Description:

1/2.  /  up/down key: on the setup display screen, a short press will change the parameter value step by step, press and hold to change the parameter values quickly; on the review display screen, short press to review the history data records one by one, press and hold to recall the history data records quickly.

3.  Memory key: on the measurement display screen, press and hold the key (for 3 seconds) to enter into the review display screen; once the review display screen, a short press will recall the history data records.

On the setup display screen, all parameters can be set in anticlockwise order by pressing and holding the "" key, similarly, a short press of the "" key will set the parameters in clockwise order.

4.  Menu key: on the measurement display screen, press and hold the menu key to enter the setup screen; on the setup or review display screen, press and hold the "" key to go back to the measurement display screen.

5.  Start/cancel button: on the measurement display screen, a short press of this button will activate or cancel the blood pressure measurement.

2.1.2 The Right and Upper Sides of the Device

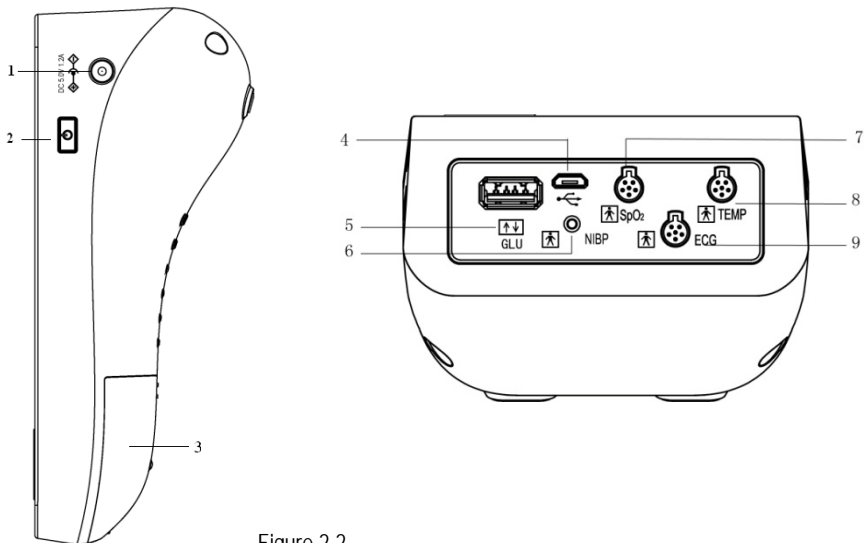
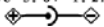





Figure 2.2

The power switch and external DC power input socket are on the right side of the monitor as shown in figure 2.2 left.

The signal input/output ports are on the upper side of the monitor as shown in figure 2.2 right.

Description:

1.  : External DC power input socket.
DC 5.0V 1.2A
2.  : Power switch (press and hold to turn the monitor on/off).
3. Battery cover.
4.  : USB data interface.
5.  GLU: Connector to link to the Blood Glucose Monitoring System.
6. NIBP: Cuff connector.
7. SpO₂: Smart SpO₂ probe connector.
8. TEMP: Temperature probe connector.
9. ECG: Connector to link with Easy ECG Monitor.

2.2 Installation

2.2.1 Power Supply

1. Internal power supply by the built-in battery

When the battery indicator " displays full grids, the built-in battery is fully charged. When it blinks, the battery voltage is low, and the user should charge the battery by connecting the device to the AC power adapter or a USB power source via USB cable. When the grids of the battery indicator are rolling circularly, the battery is being charged.

2. External power supply from the AC power adapter

Use the AC power adapter provided by the manufacturer. Make sure that the mains power supply is AC100V-AC240V with 50/60Hz.

2.2.2 Starting the Monitor

By pressing and holding down the switch, the software version will be displayed, after releasing the switch, the device will enter the measurement display screen automatically. The user can then begin to operate the monitor.

- If the monitor fails to start by pressing the switch, please use the external power supply.

2.3 Taking Measurements

2.3.1 Blood Pressure Measurement

1. Applying the cuff; unfold the cuff and wrap it around the upper arm evenly to the appropriate tightness. The correct cuff position is shown in figure 2.3.

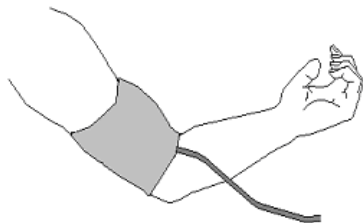



Figure 2.3 Cuff position

2. Connect the hose from the cuff to the connector on the upper-side of the device where marked "NIBP".
3. Press the start/cancel button "  " to begin the blood pressure measurement.

Safety Instructions for blood pressure measurement

- Blood pressure measurement is prohibited to those who have severe hemorrhagic tendencies or with sickle cell disease, as partial bleeding may be caused.
- An appropriate cuff should be selected according to the age and arm circumference of the patient. The cuff width should be 2/3 of the length of the upper arm. The inflatable part should be long enough to permit wrapping approximately 80% of the limb. See the table below for the dimensions:

Cuff Model	Arm Circumference
Small-sized Pediatric Cuff	10cm~19cm
Large-sized Pediatric Cuff	18cm~26cm
Small-sized Adult Cuff	25cm~35cm
Large-sized Adult Cuff	33cm~47cm

Note: The device is suitable for patient with more than 3 years old, and the appropriate cuff should be selected according to the age and arm circumference of the patient.

- Continuous measurements may result in purpura, neuralgia and lack of blood.
- Do NOT wrap the cuff on limbs with transfusion tubes, intubations or skin lesions on the area, as damage may be caused to the limbs.
- The equipment can be used on pregnant or pre-eclamptic patients, but should not be used on neonatal patients.
- The operating steps needed to obtain accurate routine resting BLOOD PRESSURE measurements for the condition hypertension including:
 - Patient position in normal use, including comfortably seated, legs uncrossed, feet flat on the floor, back and arm supported, middle of the cuff at the level of the right atrium of the heart.
 - The patient should be relax as much as possible and should not talk during the measurement procedure.
 - 5 minutes should elapse before the first reading is taken.
 - Operator position in normal use.
- Readings can be affected by the measurement site, the position of the patient (standing, sitting, lying down), exercise, or the patient's physiological condition.
- The operator should check whether the cuff is wrapped well at first if unexpected readings are obtained.

- The environmental or operational factors which can affect the performance of the device and/or its blood pressure reading (e.g. common arrhythmias such as atrial or ventricular premature beats or atrial fibrillation, arterial sclerosis, poor perfusion, diabetes, age, pregnancy, pre-eclampsia, renal diseases, patient motion, trembling, shivering).
- The performance of the equipment can be affected by extreme temperature, humidity and altitude.
- Avoid compressing or restricting the connection tubing.
- 🔔 Measurements should be taken at appropriate intervals. Continuous measurements with short intervals may lead to pressed arm, reduced blood flow low blood pressure, and result in an inaccurate reading. It is recommended that the measurements are taken in intervals of more than two minutes.
- 🔔 Before use, empty the cuff until there is no residual air inside. Do NOT allow the cuff to twist or bend.
- 🔔 Do NOT twist the cuff hose or put heavy things on it.
- 🔔 Please hold the connector of the hose while connecting and disconnecting it to the device.
- 🔔 If arrhythmia or auricular fibrillation occurs, take the measurement again.

2.3.2 SpO₂ Measurement

Operation procedures:

1. Connect the smart SpO₂ probe to the connector on the upper-side of the device marked "SpO₂". When disconnecting the connector, be sure to hold the head of the connector firmly and pull.
2. The red blinking light inside the clip of the SpO₂ probe indicates a successful connection.
3. Insert one finger (index finger is preferred, the nail should be not too long) into the clip of the probe according to the finger mark, shown as below.
4. The device will begin to take the measurement.

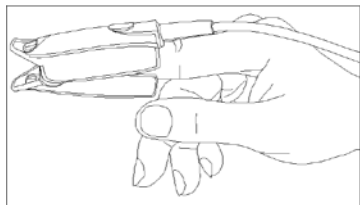





Figure 2.4 Demonstration for SpO₂ probe

Safety instructions for SpO₂ measurements

- Continuous use of the SpO₂ probe may result in discomfort or pain, especially for those with microcirculatory problems. It is recommended that the probe should NOT be applied to the same place for over two hours, change the measurement site periodically and when necessary.
- When the ambient temperature is over 35°C, please change the measuring site every two hours; when the ambient temperature is over 37°C, please do NOT use the SpO₂ sensor, as using in high temperatures can cause burns.
- Do NOT place the SpO₂ probe on a finger with edema or fragile tissue.
- Do NOT put the SpO₂ probe and pressure cuff on the same limb, otherwise the blood pressure measurement may affect the SpO₂ measurement.
- The device is calibrated to display functional oxygen saturation.
- 🔔 Do NOT allow the sensor cable to twist or bend.
- 🔔 Check the SpO₂ sensor and cable before use. Do NOT use a damaged SpO₂ sensor.
- 🔔 When the temperature of the SpO₂ sensor is abnormal, do not use it further.
- 🔔 Remove nail polish or other cosmetic products from the fingernail.
- 🔔 The fingernail should be of normal length.

-  The SpO₂ sensor cannot be immersed into water, liquid or cleanser.
-  The SpO₂ sensor can be repeatedly used. Please clean and disinfect before reuse.
-  **Connectors with the label "SpO₂"** can only be connected with the smart SpO₂ probe.

Note: The ECG and SpO₂ functions cannot be used simultaneously. If the device is successfully connected to both the ECG accessory and the smart SpO₂ probe, one function will take precedence over the other, for example of the user presses "Start" on the ECG accessory, the SpO₂ probe will be temporarily disabled until the ECG measurement is terminated.

2.3.3 Temperature Measurement

The infrared temperature probe is a delicate transducer. To operate please follow these steps and procedures. Failure to accurately operate may cause damage to the probes.

1. The infrared temperature probe

Please place the infrared temperature probe to a stable ambient temperature for 30min before measuring. If the patient sweats, please wipe the sweat. Please begin to take measurement when the temperature is stable.

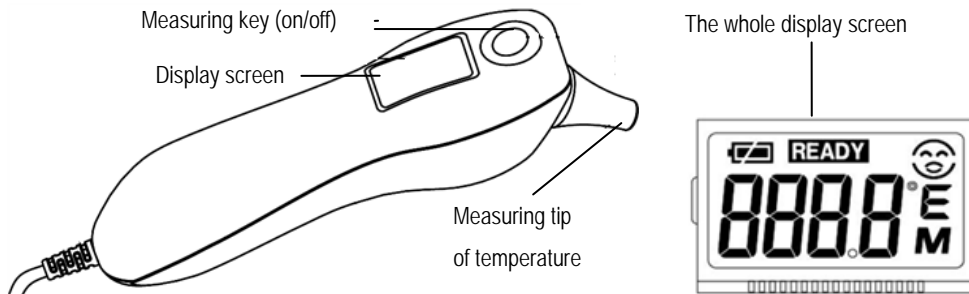

Figure 2.5 The infrared temperature probe

Operation procedure:

Step 1: Connect the infrared temperature probe to the connector on the upper side of device with mark of "TEMP".

When Monitor LCD screen displays "", it means that the probe is connected successfully.

Step 2: Power on the probe by pressing the measuring key on the probe firstly. The user can take measurement when the probe screen shows "**READY**".

Step 3: Insert the measuring tip of temperature probe into the earhole and press the power on key. One time beep means the measurement is finished and the result will be displayed on both probe screen and Monitor screen(as shown in figure 3.1A).

Note:

- If the measured temperature is between 37.5°C and 42.9°C, the infrared temperature probe screen shows "", and beeps for 4 times; If the temperature is lower than 32°C, "L" will display on both probe screen and Monitor screen; If the temperature is higher than 42°C, "H" will display on both probe screen and Monitor screen.
- If the transducer detects hardware failure, the infrared temperature probe screen will show "Err" and will not enter into measuring mode.

- The infrared temperature probe will stand by automatically if no operation for 1 min. If you need to make re-measurement, please press the measuring key and repeat step 2 and step 3.
- The measuring result will be displayed, auto stored, and can be reviewed on the All-in-One Health Monitor. Normal body temperature varies in a range. The following table shows the temperature varying range at different body position, so it is meaningless to simply compare the temperature readings from different position.

Temperature varying range at different body positions:

Arm	34.7 ~ 37.3 °C
Oral	35.5 ~ 37.5 °C
Rectal	36.6 ~ 38.0 °C
Ear	35.8 ~ 38.0 °C

Safety Instruction for Temperature Measurement

- This device meets requirements established in ASTM Standard (E1965-98).
- Do NOT using the infrared temperature probe when the subject temperature and ambient temperature are outside the operating ranges specified by the manufacturer.
- Performance of the device may be adversely affected when one or more of the following occur:
 - a. Operation outside of the manufacturer specified subject temperature range.

- b. Operation outside of the manufacturer specified operating temperature and humidity ranges.
- c. Storage outside of the manufacturer specified ambient temperature and humidity ranges.
- d. Mechanical shock.
- e. Manufacturer defined soiled or damaged infrared optical components.

 Do NOT take a measurement when the patient is moving.

 Patients with tympanitis and otitis problems should NOT use this device.

 When the infrared temperature probe is connected to the device, the probe will be powered by the device and consequently at power-on state, therefore pressing the measuring (on/off) key on the temperature probe will not cause powering off the probe.

 More information about blackbody, please contact manufacturer.

2.3.4 Blood Glucose Measurement (Optional for the specified compatible legally marketed Blood Glucose Monitoring System only)

Appearance and function of the Blood Glucose Monitoring System

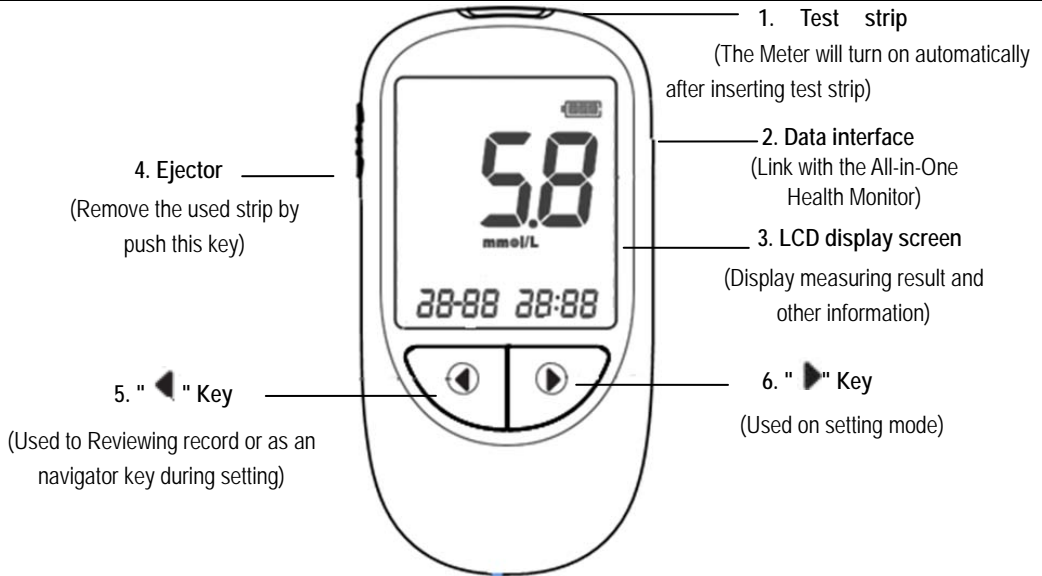

Figure 2.6 Appearance and functions of the Blood Glucose Monitoring System

Appearance and key functions of the Blood Glucose Monitoring System:

1. Test strip slot: when the strip is inserted into the slot, the device will automatically turn on.
2. LCD display.
3. Data interface: can be used to connect the All-in-One Health Monitor for data transmitting.
4. Ejector: remove the used strip.
5. ◀ key: power on/off, also for memory recalling mode.
6. ▶ key: Setting mode. Please refer to User Guide for "Blood Glucose Monitoring System" for detailed function descriptions.
7. Battery compartment (back of the Blood Glucose Monitoring System): insert 2 AAA size batteries with the correct polarities.

Operation procedure:

Step 1: Using the optional link cable for the Blood Glucose Monitoring System, connect the Blood Glucose Monitoring System to the connector on the upper side of the All-in-One Health Monitor marked "↑↓".

Step 2: When the device shows "G - -", this indicates that the blood glucose monitoring system is linked successfully.

Step 3: Take a new test strip, insert it into the test slot of the device, then the device will automatically turn on, and display the current temperature first then show the blood icon.

Step 4: Refer to the following operations for lancing device and blood lancet. When the blood drop icon appears, apply the blood drop to the front edge of the test strip, put the blood sample on the injecting hole. (Note: before making measurement, make sure the blood is full of the injecting hole.).

Step 5: The Glucose Monitoring System and the Monitor will simultaneously display the test result after about 5 seconds, the unit is mmol/L, as shown in figure 2.7A and 3.1B.

Step 6: Remove the used strips by hand or by pushing the ejector and the device will turn off and display "OFF" on the screen.

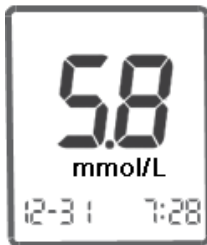

Figure 2.7 A Measuring result

Operations for the Lancing Device and Blood Lancet

1. Unscrew the lancing device by turning the end cap counter clockwise.
2. Insert a new lancet firmly into the lancet holder.
3. Twist off the protective tip of the lancet. Close the end cap of the lancing device.
4. Wipe the finger with alcohol cotton and wait it dry, then collect blood. Fingertip is preferred to be the blood collecting spot. Press the blood collecting spot slightly with lancing device and press the blood lancet button.

Refer to figure 2.7B.

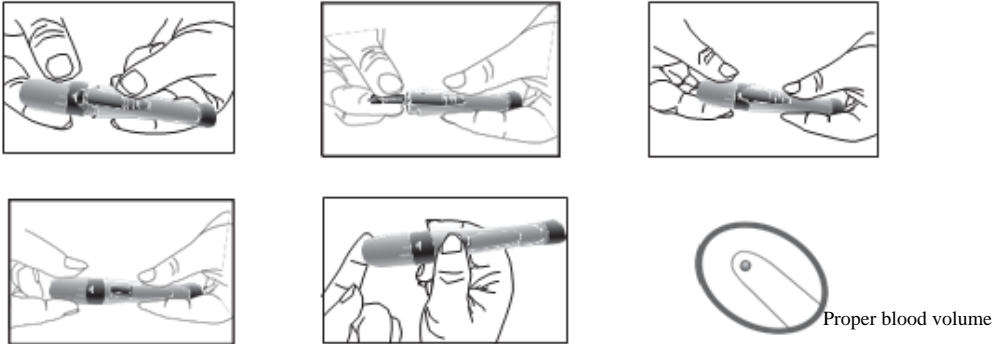









Figure 2.7B Operation for Lancing Device and Blood Lancet
Refer to the provided user guide for the "Blood Glucose Monitoring System" for further detailed instructions.

Safety Instructions for Blood Glucose Measurement

- 🔔 The provided test strips should be used with the Blood Glucose Monitoring System.
- 🔔 Do NOT clean or disinfect the finger with iodine.
- 🔔 The Blood Glucose Monitoring System will automatically switch to stand-by mode if a test strip is not inserted for 1 minute.

-  The test strip will draw blood at one end automatically.
-  Do NOT press or scrape the bleeding finger.
-  The test strip should be used as soon as possible after unpacking, and the unused strips should be kept in an airproof bottle.
-  Only take one measurement per minute.
-  If the monitor is connected with both the temperature probe and the blood glucose monitoring system, the monitor screen will show "".
-  The blood collection pinhead is a disposable item. It is recommended to insert it back into the plastic cover and throw it into a specific dustbin.

2.3.5 ECG Measurement (Optional for the specified compatible legally marketed ECG Monitor only)

1. Connect the ECG Monitor to the connector on the upper side of device marked "ECG".
2. Choose one of the methods (refer to figure 2.8B/C/D/E) to take the ECG measurement.
3. When the ECG Monitor is connected to All-in-One Health Monitor successfully, press the "Start" button on the ECG Monitor to activate the ECG measurement.
4. When "ECG" appears on the display screen of the All-in-One Health Monitor (as shown in figure 3.1C), it means the

ECG Monitor has begun to take the ECG measurement.

5. 30 Seconds later, the result will display on the screen of the host device, and the measurement will terminate.

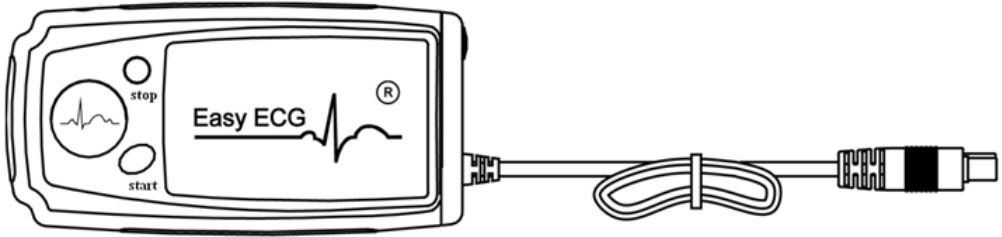

Figure 2.8A ECG Monitor

- Start / Stop: Start/Stop ECG measurement.



Figure 2.8B
Palm measurement

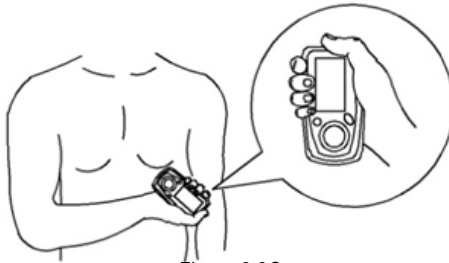

Figure 2.8C
Chest measurement

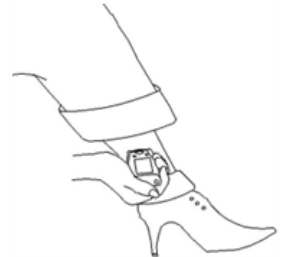

Figure 2.8D
Leg measurement

To obtain a clear and high quality ECG signal, the lead wire measurement can be used. Connect the lead wire firmly to the lead wire socket of the ECG Monitor. Place the electrodes and connect the lead wires as shown in Figure 2.8E to obtain the Lead II ECG signal. If you want to measure Lead I and Lead III ECG signal, connect the lead wires to the electrodes (note: lead wire is optional) as detailed in table below.

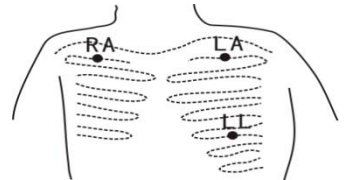

Figure 2.8E Lead wire measurement

➤ **Safety Instructions for ECG Measurement**

1. Check the ECG Monitor to make sure that there is no visible damage that may affect the user's safety and the measurement performance. If there is obvious damage, stop using the monitor.
2. Do NOT make a diagnosis by oneself according to the measurement results, always consult a doctor if abnormal information is presented frequently.
3. Do NOT use the device in a bathroom or humid environment.

Table 1 ECG Leads Configuration and Electrodes Location Table

Electrode Name& Color Electrode Location	Lead	Lead I	Lead II	Lead III
The intersection between the centerline of the right clavicle and Rib 2.		R (Red)/ RA(White)	R (Red)/ RA(White)	L (Yellow)/ LA(Black)
The intersection between the centerline of the left clavicle and Rib 2.		F (Green)/ LL(Red)	L (Yellow)/ LA(Black)	R (Red)/ RA(White)

Between the left edge of the breast bone and Rib 5	L(Yellow)/ LA(Black)	F (Green)/ LL(Red)	F (Green)/ LL(Red)
--	-------------------------	-----------------------	-----------------------

2.4 Pressure Accuracy Verification

Operation procedure:

1. Unscrew the M3x6 screw from the battery compartment on the back of the All-in-One Health Monitor, as shown in figure 2.9.
2. Take a Cuff connector plug from the battery cover, as shown in figure 2.10. (Note: there are two plugs but you will only need one.)
3. **Air Path Connection:** Take a piece of air tube (0.5~1m long, $\Phi 8.0\text{mm}/\Phi 4.0\text{mm}$ diameter). Attach the Cuff connector with a connector plug on to one end of the air tube. Connect the other end to the 3-way connector. Connect the other 2 ends of the 3-way connector to a pressure meter such as Mercury Sphygmomanometer as shown in Figure 2.12.
4. Connect the Cuff connector end to the NIBP port on the All-in-One Health Monitor.

5. Turn on the All-in-One Health Monitor. Press the menu button to go to the settings. Press and hold the large NIBP measurement button to enter the Pressure Accuracy Verification Mode.
6. Start pumping, and check if the pressure reading on the All-in-One Health Monitor matches the pressure meter reading.

M3x6 Screw



Figure 2.9

Cuff Connector Plug



Figure 2.10

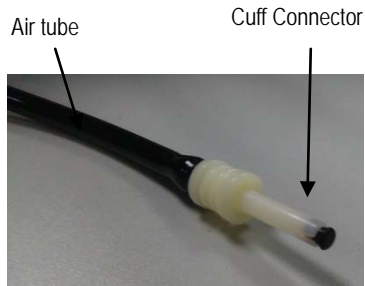

Figure 2.11











Figure 2.12





Pressure Accuracy Verification is a function to inspect the accuracy of pressure measurement by the NIBP module inside the device. Technician or equipment manager should do pressure accuracy verification every half year or year in order to check if the pressure measurement still conforms to the requirement of product performance. If the deviation is beyond the declared specification, it is permitted to return it to factory for repair or calibration. Before verification, please connect the monitor to a precise pressure meter such as a mercury pressure meter, which is used as the reference meter.

Pressure accuracy verification must be operated by technician or equipment manager. Doctor or nurse is not allowed to do the verification, it is very dangerous especially when the pressure cuff is still on patients.

2.5 Symbols

Symbol	Description	Symbol	Description
	Wireless		Pulse rate (unit: bpm, beat per min)
	Battery cover		Battery voltage indicator
	Memory icon		USB icon
	Pulse strength bar graph	bpm	Unit of pulse rate
°C/°F	Unit of temperature	kPa/mmHg	Unit of blood pressure
	Power on/off switch	DC 5.0V 1.2A 	External DC power input

User Manual for All-in-One Health Monitor

	Type BF applied parts		Charger or USB data interface
SN	Serial Number		Connector to link with blood glucose monitoring system
	Refer to manual		Follow WEE regulations for disposal
TEMP	Connector for temperature probe	SpO ₂	Connector to smart SpO ₂ probe
NIBP	Connector for cuff	ECG	Connector for ECG accessory

CHAPTER 3 MONITORING SCREEN DISPLAY

3.1 Measuring Screen

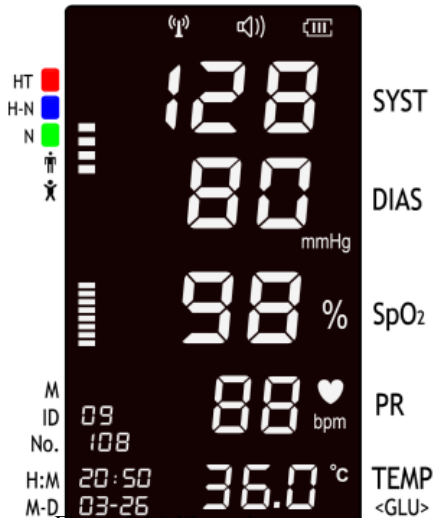

Figure 3.1C Measuring screen

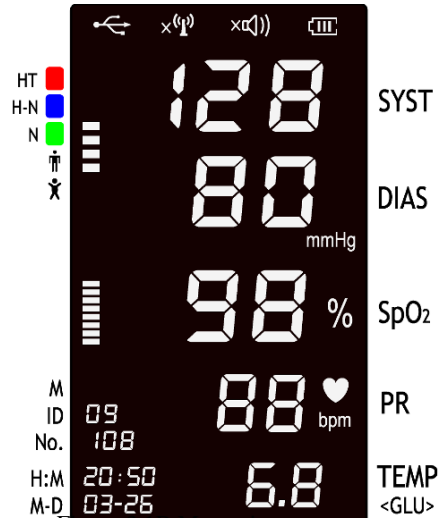

Figure 3.1D Measuring screen

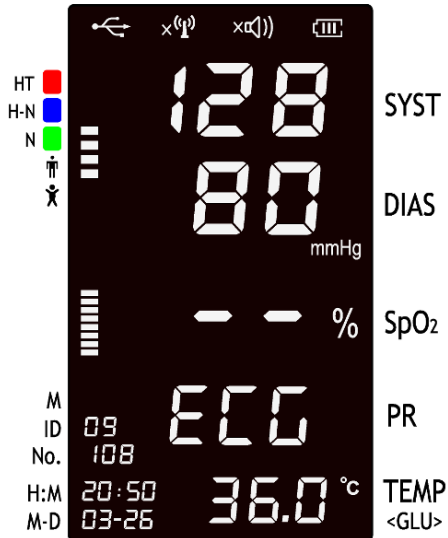

Figure 3.1C Measuring screen

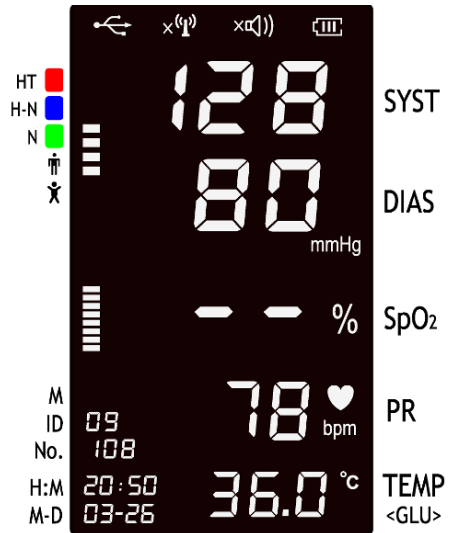













Figure 3.1D Measuring screen

Screen Description:

1. : wireless transmission icon; "": means that the wireless transmission function is on; when the icon is blinking, the wireless connection set up is unsuccessful; when this icon is steady, the wireless connection set up is successful; "": the wireless transmission function is off.
2. : Beep sound indicator; : pulse beep is on; : pulse beep is off.
3. : Battery voltage indicator. When the battery is full, the battery voltage indicator displays a full grid. When the indicator is blinking, it means the battery voltage is low and the user should charge the battery. Please connect the device to the external power supply to ensure the correct use of the monitor, and the battery will be charged. During charging, the grids in the battery indicator will roll circularly.
 HT  H-N 
4. : Means the inflation pressure during cuff inflation. When displaying the measurement result, the description for the pressure will be displayed, such as N (Normal), H-N (High normal), HT (Hypertension).
5. M: Memory
6. ID: the patient ID, which can be set from 0 to 99.
7. No.: the number of stored data, up to 999 records can be stored for each ID.
8. H:M: the time stamp (hour: minute). The time can be set in the system setup screen.
9. M-D: the time stamp (month-day). The date can be set in the system setup screen.
10. SYST(MAP): Systolic pressure
11. DIAS: Diastolic pressure
12. mmHg/kPa: unit of blood pressure, 1kPa=7.5mmHg.

13. SpO₂: the value of SpO₂ with unit of %.



14. : Pulse bar-graph.

15. PR: Pulse rate with unit of bpm.

16. : the heart beat symbol, which flashes with heart beat.

17. TEMP/GLU: the current displayed temperature with an option of °C for Celsius, or °F for Fahrenheit. When the optional GLU is chosen, the blood glucose value will be displayed with the default unit of mmol/L.









3.2 System Setting Screen

On the measurement display screen, press and hold the menu key to setup the display screen, as shown in figure 3.2. The user can choose the settings for the wireless function, pulse beep, blood pressure unit, temperature unit, date and time





Figure 3.2 System Setting screen



Operation Instructions:

1. Press and hold the "" key, and release after hearing one beep, to enter into the setup screen. When the patient ID blinks, the setup function is available.
2. A short press of the "/ " key enables or disables the wireless transmission function.
3. A short press of the "" key confirms the setting. The beeping mark "" will blink.
4. A short press of the "/ " key enables or disables the pulse beep.
5. A short press of the "" key confirms the setting. The "kPa" (blood pressure unit) will blink.

The functions of wireless transmission, beep, blood pressure unit, temperature unit, date and time can be set by following the above steps.

6. Press and hold the "" key to bring the screen display back to the measurement display screen. The monitor will also switch back to the measurement display screen if there has been no operation for 30 seconds.







Note:1. On the setup display screen, all parameters can be set in anticlockwise order by pressing and holding the "" key.

2. For setting the date, the century  is fixed to be 20, i.e. "13y" indicates the year 2013. Please see the following example:  date and time: 11:14",  date and time: 11:14", March 23, 2013.

3.3 History Data Review Screen

On the measurement display screen, press and hold the  key to recall the stored data records, as shown in figure 3.3

Operation instructions:

1. Press and hold the  key, release the key after hearing one beep. The memory mark  will appear (i.e. entering to review display screen). The patient's ID number will blink at the same time.
2. A short press of the  /  key will browse the patient's ID numbers.
3. A short press of the  key will confirm the setting, and the recorded number (No.) will blink.
4. A short press of the  /  key will set the recorded number to be recalled. The data displayed on the screen is for the specific record of the patient selected.

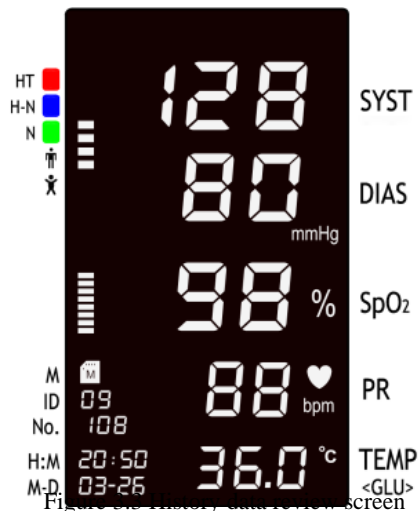

Note: when selecting the patient ID, the screen only displays patients with history data records.

3.4 Data Uploading

1. When the wireless transmission function is on, the monitor can communicate with a host for viewing and management.
 - a. Open the host 's wireless function and procedure and start to scan the PC-303 monitor.
 - b. The host will pair with the PC-303 monitor at a moment.
 - c. After connecting, the host can display and manage the measurement data of PC-303 by wireless.
- ☛ The pairing and transmitting distance of wireless function is 8 meters in the normal. If the host can't pair with the PC-303, you will try to narrow the distance between the host and PC-303.
- ☛ The PC-303 can pair and transmit with the host under the wireless coexistence environment, but other wireless device may still interface with pairing and transmission between the host and the PC-303 device under uncertain environment. If the host and the PC-303 display inconsistent, you may need to change the environment.
2. When connected to a USB cable, the history data (including the measured SpO₂, PR, TEMP and ECG data etc.) can be uploaded to host for viewing and management.

CHAPTER 4 TECHNICAL SPECIFICATIONS

4.1 Blood Pressure Measurement

1. Technique: Oscillometric
2. Pressure measuring range (Adult/ Pediatric): 0mmHg-300mmHg
3. Accuracy of pressure measurement: ± 3 mmHg
4. Overpressure protection limit (Adult/ Pediatric): ≤ 300 mmHg
5. Blood pressure measurement range (Adult/ Pediatric):
SYS: 60mmHg-255mmHg DIA: 30mmHg-195mmHg

6. Blood pressure measurement accuracy:
Maximal mean difference: ± 5 mmHg
Maximal standard deviation: 8mmHg

Note: The device is suitable for patient with more than 3 years old, and the appropriate cuff should be selected according to the age and arm circumference of the patient.

4.2 SpO₂ Measurement

1. Technique: optical with dual-wavelength

Wavelength: Red light: 663nm, Infrared light: 890nm

Maximal optical output power: less than 2mW maximum average

2. SpO₂ displayed range: 35%-100%
3. SpO₂ measuring accuracy: A_{rms} is not greater than 3% for SpO₂ range from 70% to 100%
Note: A_{rms} is defined as root-mean-square value of deviation according to ISO 80601-2-61.
4. SpO₂ display update: every second
5. SpO₂ averaging: Averages the recent eight seconds value falling within the acceptable limits.

4.3 Pulse Rate Measurement

1. PR measuring range: 30bpm~240bpm
2. Pulse rate measuring accuracy: ± 2 bpm or $\pm 2\%$, which is greater

4.4 Temperature Measurement

1. Measuring range: 32.0°C-43.0°C
2. Measuring accuracy: $\pm 0.2^{\circ}\text{C}$ is for TEMP range from 36.0°C to 39.0°C, and $\pm 0.3^{\circ}\text{C}$ is for the rest;
 $\pm 0.4^{\circ}\text{F}$ is for TEMP range from 96.8°F to 102.2°F, and $\pm 0.5^{\circ}\text{F}$ is for the rest.
3. Response time: $\leq 5\text{s}$

4.5 Blood Glucose Measurement (Optional)

1. Technique: Amperometric, glucose oxidase
2. Measuring range: 1.1mmol/L-33.3mmol/L (20-600mg/dL)
3. Measuring time: ≤ 10 seconds

4.6 ECG Measurement (Optional)

1. Heart Rate measuring range: 30bpm-240bpm
2. Heart Rate measuring accuracy: $\pm 2\text{bpm}$ or $\pm 2\%$ whichever is greater

3. Display scale: $5.0\text{mm/mV} \pm 10\%$
4. Common-mode rejection ratio (CMRR): $\geq 60\text{dB}$

4.7 Others

4.7.1 Operating Environment

1. Operating temperature: $5^{\circ}\text{C}-40^{\circ}\text{C}$; Relative humidity: 30%-80%, non-condensing;
Atmospheric pressure: $70.0\text{kPa}-106.0\text{kPa}$; Power supply: AC100V-AC240V, 50/60Hz, 15VA;
Internal power supply: DC3.7V (rechargeable Lithium battery);
2. The device should be situated in a place protected against direct sunlight, to prevent overheating inside of the equipment.
3. Do not use this equipment in combination with any equipment other than those approved in the user manual.
4. The device should be stored and used in a specified temperature, humidity and atmospheric pressure range, or damage may be caused to the device and as a consequence, record inaccurate results.
5. If the device gets wet by accident, the operator should NOT turn on the power until it has been thoroughly air dried.
6. Do not use this equipment in an environment with toxic or inflammable gases.

7. Only monitor a single person at a time.

Warning: Do not use any other adapters than those provided by Creative.

4.7.2 Classification

1. Protection against electric shock: Class II equipment and internally powered equipment
2. The degree of protection against electric shock: Type BF applied part
3. Define apply part: cuff, SpO₂ probe, temperature probe, ECG lead wires (optional).
4. The degree of protection against harmful ingress of liquid: The equipment is IPX2 with protection against ingress of liquid
5. Electro-magnetic Compatibility: Group I, Class A

CHAPTER 5 TROUBLESHOOTING

Trouble	Possible reason	Solution
Cannot turn on the device	The built-in battery is drained	Recharge by connecting the power supply adapter
	Battery is not installed	Install the Lithium battery
	Some parts provided by other manufacturers are inserted to the connector	Remove the related parts and try again.
No blood pressure result	The cuff is wrapped around the arm incorrectly	Wrap the cuff around the arm correctly
	The windpipe is not correctly inserted to the NIBP jack	Insert the windpipe to the NIBP jack
No SpO ₂ result	The SpO ₂ probe is not plugged into the "SpO ₂ " connector	Plug the SpO ₂ probe into the "SpO ₂ " connector
No TEMP result	The temperature probe is not correctly plugged into "TEMP" connector	Plug the temperature probe into "TEMP" connector

Taking measurements before "READY" appears on the temperature probe screen

Do not take a measurement until "READY" appears on the temperature probe screen

CHAPTER 6 PACKING LIST

Item	Description	Quantity	Check
1	All-in-One Health Monitor	One piece	OK
2	Handbag	One piece	OK
3	User Manual	One piece	OK
4	Cuff	One piece	OK
5	USB cable	One piece	OK
6	Charger (with USB socket)	One piece	
7	Temperature probe	One piece	
8	Smart SpO ₂ probe	One piece	
9	Blood Glucose Monitoring System (with lancing device)	One set	

	and link cable)		Optional
10	Blood glucose test strips	One pack	
11	Disposable adhesive ECG electrodes	Six pieces	
12	ECG accessory	One piece	
13	ECG lead wire (snap)	One piece	

CHAPTER 7 MAINTENANCE AND SERVICE

The All-in-One Health Monitor should be properly maintained to ensure its maximum performance and long service life. In addition to the warranty period, the company also offers long-term service for each customer. It is important that the user reads and follows the operation instructions, important information and maintenance measures.

7.1 Technical Maintenance

7.1.1 Daily Examination

Before using the monitor, the following checks should be carried out:

- Check the monitor for any mechanical damage;
- Inspect the exposed parts and the inserted parts of all the leads, and the accessories;
- Examine all the functions of the monitor that are likely to be used for patient monitoring, and ensure that it is in good working condition.









If there is any indication of damage, or if damage is accurately proven, do not use the device. Contact your supplier for advice and to reach a satisfaction solution.

7.1.2 Routine Maintenance

The All-in-One Health Monitor is designed to have a life expectancy of at least 5 years. In order to ensure precise readings, it is recommended to test the pressure accuracy every year. Please see section 2.4 to perform the Blood Pressure Accuracy Check Method or contact your supplier for more information. After each maintenance or yearly maintenance, the monitor should be thoroughly inspected by a qualified personnel, including an inventory of all functions and safety examinations.

- If the hospital fails to carry out a satisfactory maintenance program on the monitor, it may cause harm to the patient.
- If there is any indication of cable and transducer deterioration or damage, please do not use.
- The SpO₂ function has been calibrated before vending. If the user needs to verify the precision of SpO₂ function, the simulator with model FLUKE INDEX2 can be used.
- 🔔 Any adjustable unit or component inside the monitor cannot be adjusted without permission so as to avoid unnecessary failures that may affect the normal application.
- 🔔 It is recommended to use the battery once a month to ensure the battery's normal capacity and its long service life, and recharge once the battery has completely run out.

7.1.3 Battery Maintenance

-  Please pay attention to the polarity of the battery, do NOT insert into the battery compartment with reversed polarities.
-  In order to avoid damaging the battery, do NOT use other power supply devices to charge the battery.
-  After use, dispose of the battery according to local regulations, do NOT throw into fire.
-  Do NOT hit or strike the battery with force.
-  Do NOT use this battery in other devices.
-  Do NOT use this battery below -20°C or above 60°C .
-  In order to maintain the battery supply and prolong the battery lifetime, please charge the battery routinely. Regularly, charge the battery every 3 months even if the device has not been used.
-  Only use a battery with the specification recommended by the manufacturer.
-  Whether the monitor is on or off, the built-in battery will charge as long as the monitor is connected to an AC adapter and the AC power is on. When the battery is full, it will stop charging to avoid causing any damage. If the monitor is connected to an AC adapter and the AC power is on, it will use the AC power, but when the AC power is off, the battery power will be used. Priority of using the AC power and the power switch between AC and

battery is automatic and seamless.



If the battery is damaged, please replace it with a battery with "CCC" or "CE" mark. The model and specifications of the battery should be the same as the original battery. The user must ensure that the battery meets all applicable safety codes. The user can also contact the distributor for service.

7.2 Cleaning and Disinfection of the Main Unit

The device should be cleaned on a regular basis. If there is heavy pollution or lots of dust and sand in your place, the device should be cleaned more frequently.

The exterior surfaces of the device may be with a clean and soft cloth, sponge or cotton ball, dampened with a non-erosive cleaning solution. Dry off excess cleaning solution before cleaning the device is recommended. Following are examples of cleaning solutions:













- Clear water
- Dilute the cleaner.
- Alcohol impregnated



Switch off the monitor and disconnect the power cord before cleaning.









Keep the monitor free from dust.

-  It is recommended to regularly clean the outer shell and screen of the monitor. Only use a non-corrosive cleanser such as clear water.
-  Wipe the surface of the monitor and transducers with an alcohol impregnated wipe, and dry with a clean cloth or just air-dry.
-  Dilute the cleaner.
-  Do NOT use scrubbing materials.
-  The monitor can be disinfected. To avoid damage do not let liquid cleaner flow into the connector jack of the monitor.
-  Clean the exterior of the connector only.
-  Do NOT let any liquid flow into the shell or any other parts of the monitor.
-  Do NOT leave any residue liquid or disinfectant on the surface of the monitor.
-  Do NOT perform high pressure sterilization on the monitor.
-  Do NOT immerse any parts of the monitor or its accessories in liquid.
-  If the monitor accidentally becomes wet, it should be thoroughly dried before use. The rear cover can be removed by a qualified service technician to verify the absence of water.
-  Do NOT pour disinfectant on the monitor's surface while disinfecting.

7.3 Cleaning and Disinfection of Accessories

It is recommended to clean and disinfect the accessories with a piece of gauze soaked in 75% Alcohol or 70% Isopropanol.

-  Do not use damaged accessories.
-  Accessories cannot be entirely immersed into water, liquid or cleanser.
-  Do NOT use radiation, steam or epoxyethane to disinfect accessories.
-  Wipe off any remaining residue of alcohol or isopropanol after disinfection.
-  Disinfect the temperature sensitive probe with alcohol.
-  Wipe the thermometer clean with a mild cloth if it becomes dirty.
-  Wipe the thermometer clean and return to packaging after use.

7.4 Storage

If the equipment will not be used for a long time period of time, wipe it clean and return it to the packaging. Store in a dry well ventilated place free from dust and corrosive gases.

Storage environment: Ambient temperature: -20°C~60°C

Relative humidity: 10%~95%, non-condensing

Atmospheric pressure: 53.0kPa~106.0kPa

7.5 Transportation

The monitor should be transported by land (vehicle or railway) or air in accordance with the contractual terms. Do NOT hit or drop with force.

Warranty Clause

1. This monitor has a warranty of 12 months (including rechargeable battery) and 6-month for all accessories, from the date of purchase.
2. It is recommended to use the original packing boxes and packing materials when returning for repair or maintenance
3. Please send the device to the specified place for repair.
4. The following will invalidate the warranty:
 - ✧ If the monitor is damaged due to misuse or incorrect operation (i.e. without the user manual instruction).
 - ✧ The monitor is damaged due to incorrect connection with another instrument
 - ✧ The monitor is accidently damaged, dropped or immersed into water
 - ✧ If the user modifies or changes the monitor without written authority of the company

- ◇ If the serial number is deliberately damaged, torn off or unreadable
5. If the monitor is non-functional outside of the warranty period, the manufacturer or distributor will offer an estimate for repair.

Caution:

This equipment has been tested and found to comply with the limits for a Class B digital device, pursuant to part 15 of the FCC Rules. These limits are designed to provide reasonable protection against harmful interference in a residential installation. This equipment generates uses and can radiate radio frequency energy and, if not installed and used in accordance with the instructions, may cause harmful interference to radio communications. However, there is no guarantee that interference will not occur in a particular installation. If this equipment does cause harmful interference to radio or television reception, which can be determined by turning the equipment off and on, the user is encouraged to try to correct the interference by one or more of the following measures:

- Reorient or relocate the receiving antenna.
- Increase the separation between the equipment and receiver.
- Connect the equipment into an outlet on a circuit different from that to which the receiver is connected.
- Consult the dealer or an experienced radio/TV technician for help.

This device complies with part 15 of the FCC Rules. Operation is subject to the following two conditions: (1) This device may not cause harmful interference, and (2) this device must accept any interference received, including

interference that may cause undesired operation.

Any Changes or modifications not expressly approved by the party responsible for compliance could void the user's authority to operate the equipment.

Device Information:			
Name		Model	
Serial Number:			
Date		Shop	
User Information:			
Name		Postcode	
Tel:			
Add:			
Repair Record			
Date	Repairing Item	Personnel	

Patent

State Intellectual Property Office of the P.R.C. patented and certificated Creative All-in-One Health Monitor on March 26th, 2014.

Patent Number: ZL 2013 2 0615696.X

Shenzhen Creative Industry Co., Ltd.

2/F, Block 3, Nanyou Tian'an Industry Town,
518054 Shenzhen, GD, P.R. China

Tel: +86-755-2643 3514

Fax: +86-755-2643 0930

E-mail: info@creative-sz.com

Website: www.creative-sz.com